



SASKEN



Environmental  
Management and Conservation -  
The Sasken Way!



# Table of Contents

About Sasken	4
Why do we need to worry about Environmental Conservation?	5
Our Approach	6
Afforestation and Reforestations	7
Soil Preservation and Pesticide free Farming	9
Water Conservation and Rainwater Harvesting	11
- Soak Tank Construction at Campus, in pictures	12
- Reduce Water Usage Within the Campus	13
Waste Management and Reduce Pollution	14
- Waste Management Within the Campus	16
Using Eco-sustainable Energy Alternatives	17
- Renewable Energy for the Campus	18
- A first step towards Carbon Neutrality	19
- Donation of Refurbished Computers	20
- Reduce Paper/Media Save Environment	21
Various Educative Series Conducted in Sasken Through the year to Conserve Natural Resources	22
Awards and Recognition	25
Message from the CEO & MD to the Employees	27

# About Sasken



Sasken is a specialist in Product Engineering and Digital Transformation providing concept-to-market, chip-to-cognition R&D services to global leaders in Semiconductor, Automotive, Industrials, Consumer Electronics, Enterprise Devices, SatCom, Telecom, and Transportation industries. For over 30 years and with multiple patents, Sasken has transformed the businesses of 100+ Fortune 500 companies, powering more than a billion devices through its services and IP.

Established in 1989, Sasken employs around 1700 people, operating from state-of-the-art centres in Bengaluru, Pune, Chennai, and Kolkata (India), Kaustinen and Tampere (Finland), and München (Germany). Sasken also has a presence across Japan and UK. Sasken has been listed in the National Stock Exchange and Bombay Stock Exchange Ltd. in Mumbai, India since its initial public offering in 2005.

Sasken's solutions are backed by CMMI-DEV-V1.3-ML3, ISO 9001 (QMS) and ISO/IEC 27001 (ISMS) certifications. Sasken's proprietary quality management system strengthens its business offerings and ensures client satisfaction. Sasken's commitment to environment, health and safety is backed by its ISO 14001 (EMS) certification.

Sasken is compliant to ISO 26262 Road Vehicles-Functional Safety standard for Management of Functional Safety, Software Product Development, and Supporting Processes.

# Why do we need to worry about Environmental Conservation?

*We only have one planet on which we live. The planet is full of resources, some renewable and some not, but unfortunately, we have an ever-growing population that poses a huge threat to all these resources. It is therefore unclear what future generations will find, if ever, and what life will be like for them if we exploit all the current resources.*

The Earth is the only planet to live on. This planet is full of resources, some of which are renewable and some are not. But, unfortunately, we have an ever-growing population that poses a huge threat to all these resources. It is, therefore, unclear what future generations will find, if ever, and what life will be like for them, if we exploit all the current resources.

Environmental conservation is the practice of we humans to save the environment from the loss of species, and the destruction of the ecosystem, primarily due to pollution and human activities. Conservation is vital in saving and helping both animals and trees, as we all are dependent on one another for our survival.

Trees convert carbon dioxide produced by factories into oxygen, which helps us breathe and respire. The loss of species, which makes them go extinct, would mean they are forever lost and could never be seen by the curious eyes, or studied by the scientific minds, in future. Additionally, such loss or destruction of ecosystems would disrupt the food web, messing up the whole ecosystem in general.

There is much to do when it comes to rebuilding and protecting what's left of natural resources and the biodiversity within our ecosystems. Environmental conservation is an umbrella term that defines anything we do, to protect our planet and conserve its natural resources, so that every living thing can have an improved quality of life.

Environmental conservation and preservation are two terms that are often used interchangeably, although they are quite different. Conservation refers to the responsible management of the environment and its resources for present and future use. Preservation, on the other hand, is a much stricter approach where the environment, lands and natural resources are put away, not to be consumed by humans, but are instead maintained in their pristine form. If the land is to be used by humans, it should only be utilized for its natural beauty and inspiration.

Conservation works in two ways. Firstly it protects nature by protecting vital resources, and secondly by a way of living that controls and contains the irresponsible practices of businesses and large corporations.

Environmental conservation comes in many forms and constantly reminds us to be mindful of our daily choices. No matter how busy our life may be, it remains easy to make small, yet necessary, changes for the good of the planet Earth.

If we all took small steps, we would make our way towards major progress. This can be achieved by paying more attention to everything that we do in our daily life.

As an organization having highest sensibilities and corporate social responsibilities, Sasken Technologies has inculcated all these fine and simple steps in its corporate life and is striving hard to ensure that we, as an organization, and our employees do a bit to protect our mother earth for the coming generations.

# Our Approach



*Sasken's Environmental Sustainability initiatives is driven by a in house team called Prakriti. Prakriti as we all know means NATURE. The group has a charter to work on various Environment conversation activities through the year and educate the new employees joining the organization with the organizational initiatives, which in turn help to spread the much-needed awareness. However, at Sasken, education is not limited to "Awareness Session", most of the education is practical and on the ground and the results of the same is tracked, measured, and we take pride in communicating and publishing the same year on year.*

This approach guarantees two things to the organization as well as its employees, (a) Accountability (b) Satisfaction of seeing positive changes happening in front of their eyes.

Over the last few years, Sasken has implemented various sustainable initiatives in the organization. Every aspect of Administration is looked at as an environmental aspect and the impact thereof, is measured to provide solutions and alternatives. The main focus is on Reduce, Recycle and

Reuse at every step. This has helped in many things like waste disposal, reducing carbon footprint, food waste management, water conservation and using eco-sustainable alternatives in various domains.

Much of these initiatives which we carry out within the organization and also for the society is classified into 6 major areas.



**Afforestation and reforestation**



**Soil preservation and pesticide free Farming**



**Water conservation and Rainwater harvesting**



**Waste management and reduce pollution**



**Eco-sustainable energy alternatives**



**Constant Education and Awareness**



## Afforestation and Reforestations

Afforestation and reforestations help in conserving the forests, which are responsible for trapping/absorbing a huge amount of carbon dioxide from reaching the atmosphere. Afforestation also helps in reducing soil erosion and landslides to large extent. We should make it our life mission to plant as much trees as possible, both on public and private lands, and take care of them. Additionally, legislation that protects the forests should be highlighted, so that we help in environmental conservation.

At Sasken, when we wanted to do our bit towards afforestation, we did consult many experts on the best possible methods. While Software development is our main profession and we cannot afford to set aside much time for running a plantation drive across the state year after year, the urge to do something for the society at large pushed us to select an interesting alternative technology or the technique of creating seed balls which was rediscovered by Japanese natural farming pioneer **Masanobu Fukuoka**.

Seed balls, also known as earth balls, consist of a variety of different seeds rolled within a ball of clay, red clay. Various additives may be included, such as humus or compost. These are placed around the seeds, at the centre of the ball, to provide microbial inoculants.

Once the seed balls are ready, these are taken into deforested area or to the by lanes of highways where deforestation has occurred. These seed balls are scattered in these barren areas the method which is called seed bombing. This is also called as guerrilla gardening.

Every year we at Sasken make not less than 5000 seed balls and distribute to our employees, who take them and scatter where they want to see the forest grow. This is typically done during monsoon season. While success rate of these seed ball growing into a plant/tree might be about 50%, but the fact that it is easy and simple method and can be done by any and every age group, makes it more interesting and effective.

While we do such activity, we also invite neighbouring Govt school students and teach them the technique of seed ball making as well as the essence of afforestation. We do visit Schools and conduct awareness to students on the importance of growing trees/forests.





Seed Ball making drive at campus and education at Schools

- Every year we make 5000 seed balls consisting of various fruits/raintree seeds and scatter them in the deforested areas in Karnataka.
- Even at 50% success rate we are contributing towards 2500 Saplings plantation every year.
- Barring Pandemic, every year we make it a practice to teach young students from a few school, on the importance of Afforestation.





## Soil Preservation and Pesticide free Farming

Soil stands as its own supporter of life by acting as a supplier of food and a filter of water. Soil that is of good quality produces crops that feed humans and animals.

Plants and flowers sprout up from the ground through the soil, help in regulating the climate. Most of nature's water isn't made fit for human consumption, but soil also stores groundwater and filters it, making it safe for drinking.

Long-distance transportation of produce relies heavily on fossil fuels. Growing our own food would help reduce the reliance on this transportation that is harming the environment. Also, by growing our own food, we are not using chemicals or pesticides which harm environment. Keeping this in mind Sasken started to produce Organic vegetables in the vacant land in the campus.

The derivatives of such initiative have helped the employees of the organization in:

- Understanding and appreciating pesticide free farming
- Participate and grow their own vegetables, if not all, to some extent
- Educate themselves on effects of soil erosion.
- Educate themselves on natural farming techniques.
- Understanding and appreciating the need of farming for the nature's survival.

What started as an initiative of the interested group of employees, had grown into full blown farming and had been featured in many reputed Magazines/TV Channels

- The news minute – Organic Farming  
<https://youtu.be/5rypTYnBrIg?t=99>
- Bangalore mirror -  
<http://bangaloremirror.indiatimes.com/bangalore/cover-story/this-it-firm-in-domlur-grows-its-own-veggies/article-show/57818130.cms>
- WION –Organic Farming -  
<https://www.youtube.com/watch?v=CtOgnadKPWM&t=756s>
- The mint -  
<https://www.livemint.com/mint-lounge/business-of-life/gardening-in-my-office-backyard-1569342203063.html>
- The better India -  
<http://www.thebetterindia.com/93334/bengaluru-it-comp-any-organic-garden/>





Growing organic vegetables in the campus

- Sasken is producing organic vegetables in the vacant land in the campus.
- Vegetables produced by Sasken is distributed every Friday to the employees at concession rates.



# Water Conservation and Rainwater Harvesting

One of the prominent aspects of environmental sustainability is water conservation. Groundwater is the primary source of freshwater that caters to the demand of ever-growing domestic, agricultural, and industrial sectors of the country. Over the years, it has been observed that the exploitation of groundwater resources for everyday domestic needs, like drinking, washing, bathing, and cleaning, agriculture, industrial and ever-changing lifestyles with modernization are, leading to tremendous wastage of water.

According to MET department, the average rainfall in Bengaluru, has been documented as 970-975 mm, with the average number of rainy days as 60 in a year. This is huge advantage for Bengaluru. If rainwater is harvested effectively, there is a possibility to reduce water scarcity at least by 30% in the city. For this to happen each institution be it Govt or private, household, farm and park should setup effective rainwater harvesting solution.

### Rainwater harvesting at Sasken - Project Overview:

- Project start Date: 01 Oct 2020
- Project implemented date: 11 Nov 2020

### Assessment on Water Runoff in Sasken Campus:

- The average rainfall in Bengaluru, has been recorded as 970-975 mm, with the average number of rainy days as 60 in a year.
- Roughly 6190 KL of water can be redirected to recharge the wells in each monsoon in our campus.

Sr. No.	Type of land in use	Area in Sq meter	Runoff coefficient	Annual runoff at 974.5 mm rain (KL)
1	Roof area	4000	0.9	3600
2	Paved area	2500	0.9	2250
3	Central courtyard & Landscape area	1700	0.2	340
	<b>Total</b>	<b>8200 Sq. mtr</b>		<b>6190 KL</b>

Above table indicate the water runoff estimation in Sasken campus

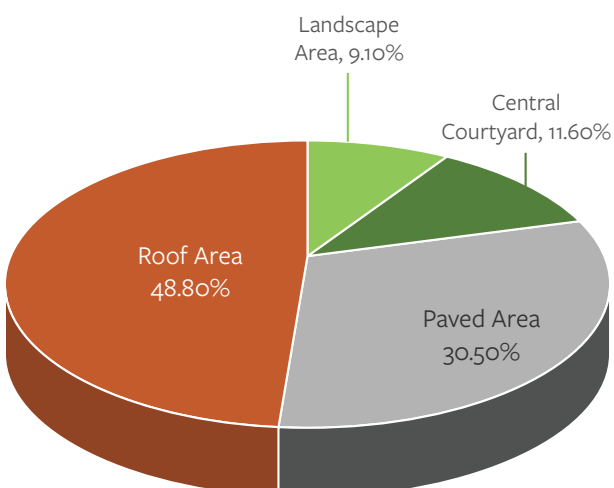

Above chart water run off areas in the campus in %

- Our annual water demand is 7800 KL
- Water usage per day is 25KL (26.3 Litre/person/day – at an average of 950 employees in the campus)
- If we, annually recharge the ground water with 6190KL water, the net water requirement can be considered as - 4.8 KL (5 Litre/Person/day)
- This effectively means that in an ideal scenario 79% of water can be returned to earth.
- To bring this into effect 10 No's of Soak tanks and 1 open well were constructed
- Pit is covered with a strong concrete lid, making it a Soak Tank.
- This soak tank can store the water depending on the volume of the tank and gradually soak that water into the ground ensuring no loss of water

## Soak Tank Construction at Campus, in pictures:



Digging of soak tank



Installation of Concrete rings



Soak tank surrounding covered with gravels



Double layer filter installed for the soak tank



Soak tank with filter membrane

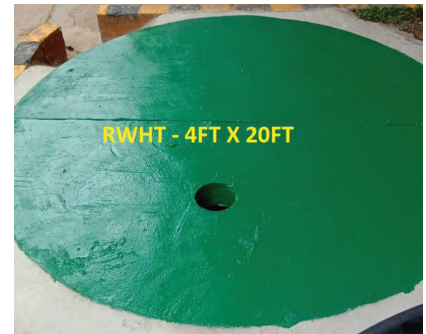

Finished Soak tank covered with a layer of mesh and concrete cap



Harvesting and collection of rainwater is an adequate strategy that can be used to address the problem of water crisis we are facing. The use of a rainwater harvesting system provides excellent merits for every community. This simple water conservation method can be an incredible solution in the areas where there is enough rainfall but not enough

supply of groundwater. It will not only be the most sustainable and efficient means of water management but would also unlock the vista of several other economic activities, leading to the Empowerment of people at the grass-root level.

- On an average rainfall year, we will recharge 6190KL of ground water by means of Rainwater harvesting



Our Goal and efforts are towards:

- Reduce our Water Footprint
- Recharge as much as Possible
- Recycle 100% of Water

## Reduce Water Usage Within the Campus:

At Sasken, every drop of wastewater is recycled and reused. In our corporate campus we recycle almost 500KL of water every month, and that almost fulfils our need for common usage (like rest room, gardening, cleaning etc). Each of the water flow areas (like Taps in the wash basins) is fitted with Improved version of Aerators, which arrests 60% water flow compared to a normal tap there by reducing the wastage of the potable water. A constant education on this to the users in the form of mailers, communication, demos has resulted in drastic water saving in the campus. We are proud to say that at Sasken "Every Drop" of water is used judiciously and there is no word called "Wastewater".

We have implemented a RO plant inside the campus and ensure that we do not buy drinking water. We have gone to the extent of designing our own Steel bubble top dispensers replacing plastic bubble top dispenser as it is harmful.



In house Ro Plant and unique steel bubble top dispensers designed by Sasken

- We recycle 50KL of water every month
- By means water foot print reduction exercise we are constantly saving 15K litre of water in the campus every month
- By means of inhouse RO Plant we reduce 0.04 tons of CO2 emission per month



## Waste Management and Reduce Pollution

De-Centralized Waste Management could be one of the solutions to the mounting Challenges in Waste management in Metros. For a while Sasken Management was thinking on the idea of setting up a waste management plant in its locality, which could help the entire neighbourhood to dispose waste in a eco-friendly manner and thereby reduce Carbon foot print and also contribute towards Swachh Baharat Abhiyan.

After studying how the waste management process works under the management of Bangalore Maha Nagara Palike, Sasken decided to set up a “Garden leaf composting plant” to start with.

Composting the garden leaves is the most eco-friendly alternative to burning, which is the prevailing practice.

The dry leaves alone would take a long time to break down. However, using a technology of introducing bio-enzymes and rich sources of nitrogen, makes them break down and compost quicker to produce rich source of manure. This manure can be used across parks in the neighbourhood, with this intent Sasken Green lighted the Project “Garden Leaf Composting Unit for the Neighbourhood”.

Success criteria of the project was, to set up a Unit which can process about 1000Kgs of Dry leaves on a daily basis, and which can produce an Organic Manure of about 400 Kgs per every input of 1000Kgs of Leaves at the end of each curing cycle.

Convincing the Local Corporator to Team up with Sasken and approach the “Bangalore Bruhat Maha Nagara Palike” to lease a 0.33 acre of unmanned park in the vicinity on Sasken Corporate office, was the first Hurdle Sasken had to pass through.

Since the unit was to be setup adjacent to the Busy Main Road (Old Airport Road, Domlur), Sasken wanted the unit to look very Aesthetic in design, less or no smell generated from the Plant and mainly participation from entire resident community of Domlur/Indiranagar so that the Unit is successfully utilized, and we create a pollute free neighbourhood.

Bangalore MahaNagaraPalike, Citizens of Domlur Layout and Environment at large are the beneficiaries of this project.

Paura Karmikas who used to Sweep the streets, garden and used to burn the Garden Leaves /Garden waste now just have to collect the same and send it to the Composting Unit for composting.

Citizens of the Layout get a clean and neat surrounding. There is now a sense of responsibility shown by all the residents and they too ensure that there is no burning of dry leaves in the neighbourhood. All the dry leaves are moved to the Composting unit.

Added to this the air pollution which was caused due to burning of Leaf's has considerably reduced now.

- We compost approximately 7000 Kgs of dry leaves every month there by reducing 0.4 tons on CO2 emission per month



Dedicating Organic waste composter to the Domlur layout



Our Goal and efforts are towards:

- Refuse, Reduce, Reuse, Recycle and move towards Zero waste

## Waste Management Within the Campus:

Sasken is a zero-waste campus. All the Paper waste is donated to Khadi GramaUdyog for recycling, all the food waste are recycled within the campus using the Bio-gas Plant. At Sasken we have set up a process for reducing and recycling the waste and that process has rendered Sasken as zero waste campus over the years. The usage of Plastic is banned inside the Sasken Campus.

Our efforts got featured in reputed Magazine.

- Indian Express - <http://www.newindianexpress.com/cities/bengaluru/2019/jun/26/city-firms-techies-turn-eco-warriors-1995358.html>



Waste segregation and Food waste management

- We convert approximately 550 Kgs of wet waste into Bio-gas in the campus on a monthly basis
- In a year we donate approximately 1.5 tons of waste papers /packing materials for Khadi Gram Udyog
- By means of no tissue day we save about 38,000 foils of tissues every year. There by saving 3 trees
- By means Digital PO, we save about 4400 papers per year.





## Using Eco-sustainable Energy Alternatives

Meeting the world's need for energy in a sustainable way is one of the greatest challenges faced by the humanity in the 21st century. The global energy system, which is 85% based on fossil fuels, is responsible for over 70% of the greenhouse gas emissions that cause climate change. Burning fossil fuels and biomass is a major contributor to air pollution, which causes an estimated 7 million deaths each year. More than 750 million people lack access to electricity and over 2.6 billion rely on polluting fuels such as wood or charcoal to cook.

When Sasken wanted its CSR to make a difference in the area of Eco-sustainability, we carried out a research to find out on how we could make a difference in people's life, who had limited or no access to power most of the day, forget about clean and green Energy. Hence we chose a village in Karnataka, called "Belgavadi".

'Light' is something that eluded the Belgavadi village on the outskirts of Bengaluru. Eponymous with light, the 1,500 population of the village literally had a tough time to get two hours of power every day. Despite their efforts they could not have assured stream of electricity to their village.

Sasken Technologies took the technology of IIT Madras and its implementation partner Cygni and started the electrification project under its CSR initiative. Almost all houses of the village are powered by 125 Wp solar unit on top of their houses.

The power generated throughout the day is enough for every household to switch on three bulbs, a tube light, and a fan for an entire day, besides allowing them to charge mobiles and other gadgets effortlessly.

Each of these homes have been installed with the Inverterless System, which typically consists of one 125Wp solar panel, one 1kWh battery, an Inverterless controller unit and DC loads operating on a 48V DC internal distribution line.

The DC loads provided on this line includes one DC fan, one DC tube light, two DC bulbs, one DC mobile charger, one DC socket and one remote controller to operate fan and tube light.

All the installations have been completed by 15th February 2017 and have been commissioned thereafter. The performance and health of all the installed systems are being monitored remotely, with the data from the Inverterless systems being collected via Bluetooth on mobile phones and synced to a central server.

A designated person was appointed to manage the installation and provide support response time of 15 minutes all through the year.

Entire Belgavadi village now stands as an example of how India can pro-actively choose to use roof-top solar panels to draw clean and reliable power.

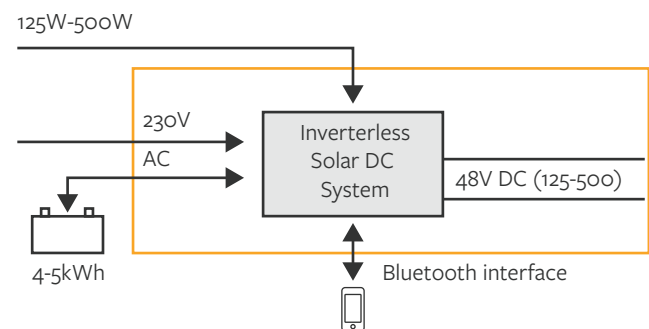

Pictures from the Belgavadi Village, Karnataka

## Renewable Energy for the Campus:

---

Not only providing renewable energy support to villages through our CSR projects, Sasken itself is using renewable energy for its consumption in the corporate campus.

Renewable Energy Sources are those energy sources which are not destroyed when their energy is harnessed. Human use of renewable energy requires technologies that harness natural phenomena, such as sunlight, wind, waves, water flow, and biological processes such as anaerobic digestion, biological hydrogen production and geothermal heat. Amongst the above-mentioned sources of energy there has been a lot of development in the technology for harnessing energy from the wind.

Wind is the motion of air masses produced by the irregular heating of the earth's surface by sun. These differences consequently create forces that push air masses around for balancing the global temperature or, on a much smaller scale, the temperature between land and sea or between mountains.

80% of the Sasken Campus power requirement is sourced through wind energy which is renewable. We procure our wind energy from Govt approved Mysore Mercantile from its Raichur plant. We offset this to BESCO every month through the wind Grid Based out of Raichur.

Besides this, Sasken is the first organization in the Karnataka state to implement roof top Solar DC technology to lit up its entire parking floors and was awarded by the Economic times for the Smart Green Technology.



- 80% of our annual power consumption in the campus is powered by Green/Renewable Energy.
- By switching over to LED Sasken has reduced 10 tons of CO<sub>2</sub> emission month on month from July 2019.
- Sasken is the first company in Karnataka to try and Implement Solar DC technology for its campus, 2015 (technology is invented by IIT Madras).

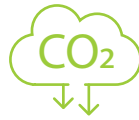

Our Goal and efforts are towards:

- Measure carbon emission in every Aspect of Business
- Improve process to reduce Carbon emission in every aspect

## A first step towards Carbon Neutrality:

Why Measure Carbon foot print: It is one of the most common measures of the effect of an individual, community, industry, or country on the environment. An increase in greenhouse gas emissions, and therefore in carbon footprint, is the primary event associated with climate change that has led to global warming. The total amount of greenhouse gases produced to directly and indirectly support human activities, usually expressed in equivalent tons of carbon dioxide (CO<sub>2</sub>). Carbon emissions is destroying our environment every single day. Our world is slowly deteriorating because of all the non-environmentally friendly actions we do, such as driving inefficient cars, buy

goods produced from unregulated factories, and so on. Carbon emissions negatively impact the environment and the health of humans. It causes the global temperature to rise which creates severe weather events, like heat waves or forest fires. Increase in temperature affects many wildlife species, putting them in great amounts of stress potentially causing extinction. As a responsible corporate citizen Saska has started putting measures and controls since 2018. Then on, the stringent measures implemented at Saska has ensured that our carbon emissions has reduced drastically. This is our first steps towards Carbon Neutrality.

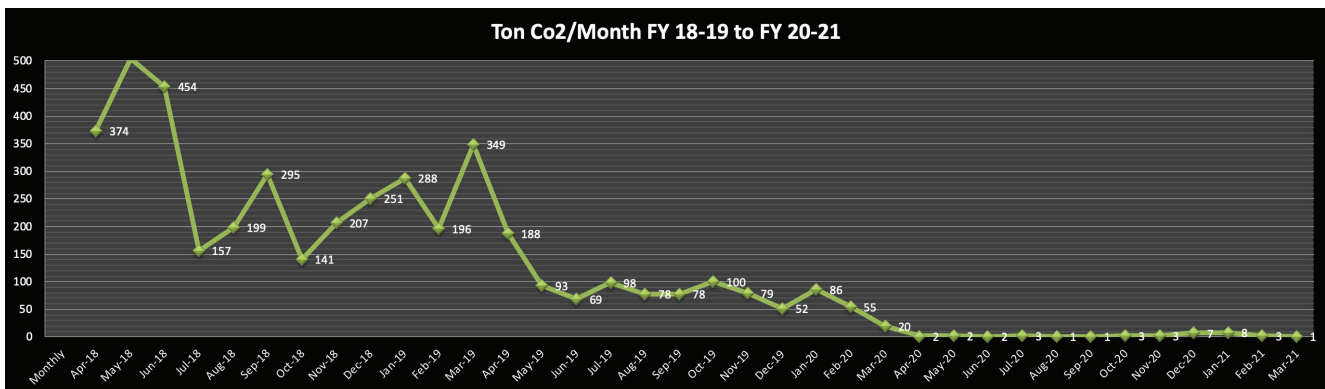

- CO<sub>2</sub> Emission which was 504 Tons per month in 2017, has now reduced to less than 100 tons per month

## Donation of Refurbished Computers

World's E-Waste to grow 33% by 20-21, says global report. Millions of computers and laptops are dumped every day, informal processing of electronic waste in developing countries may cause serious health and pollution problems, as these countries have limited regulatory oversight of e-waste processing. This also increases Land dumping which leads to environment pollution.

While it is our mission to reduce waste generation / zero dumping/safe disposal, our interest to bridge digital divide goes back to year 2014. That is when we have started the policy of donating Desktops and Laptops which has couple of years of life and can be made use in underprivileged and remote schools. Desktops, Laptops and Peripherals donated thus is changing lives, creating opportunity and helping to eliminate the digital divide for the students in such schools.

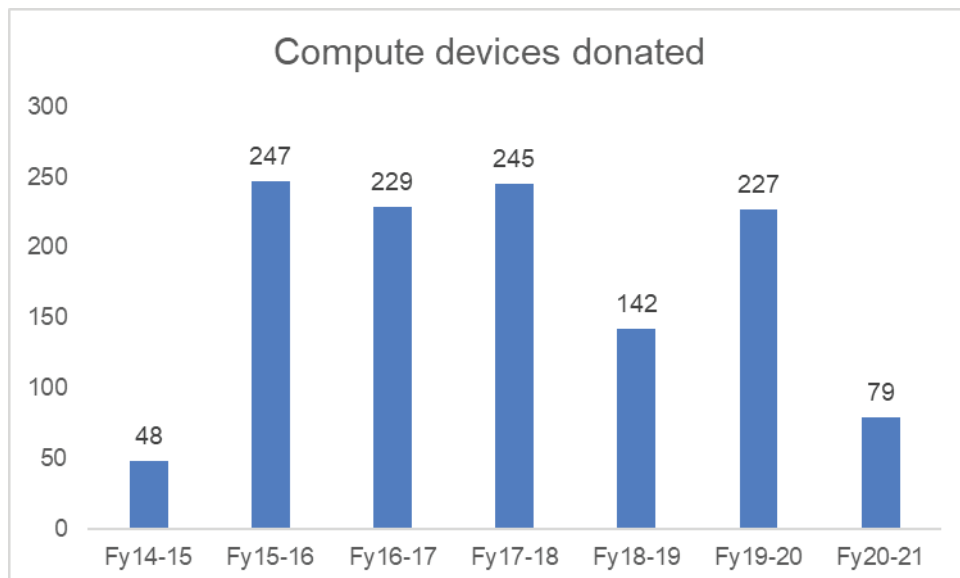

## Reduce Paper/Media Save Environment

While Data backup is a much needed requirement of an organization, using different Media for data backups has its own merits and demerits. At Sasken our offsite vaulting is on Tapes. We have put a program which ensures that the Tapes consumptions is rationalized over the years, despite of

Volume of data increasing in leaps and bounds. Of course with our compromising data safety. By means of doing this, the entire echo reduces the usage of carbon emission, which otherwise is used in manufacturing, shipping, storing in temperature controlled rooms.

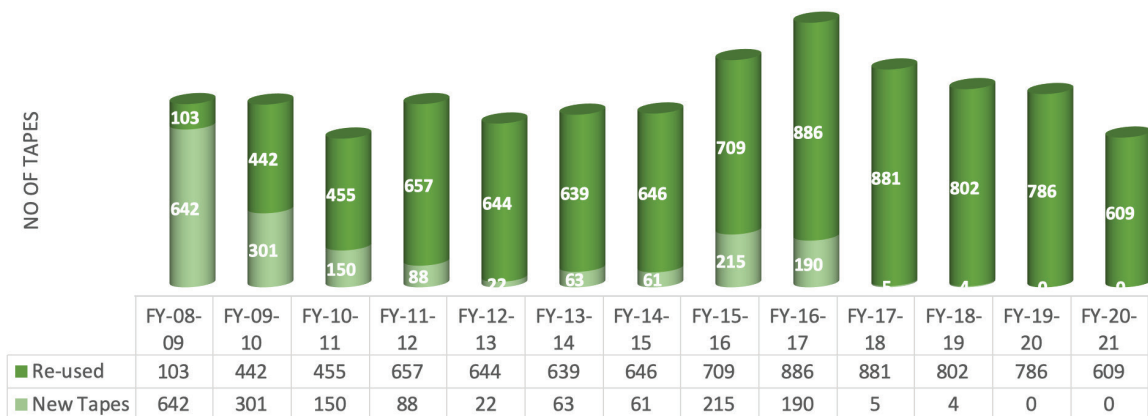

**Backup Tape Reduction and reutilization efforts**

Recent study found more than two pieces of paper are used for every person on Earth every hour, and demand for paper is expected to double by 2030. Add to this the energy usage of printers, toner, and other replacement parts, and it's clear that organisations can have a significant environmental impact by reducing waste.

As an environmentally sustainable organisation we detailed audits and reports of our print environment that show detailed breakdowns of usage by groups, locations, printers, or even individual employees. This has led us to set an improvement in process ensuring our print consumption has drastically reduced from 2009 onwards.

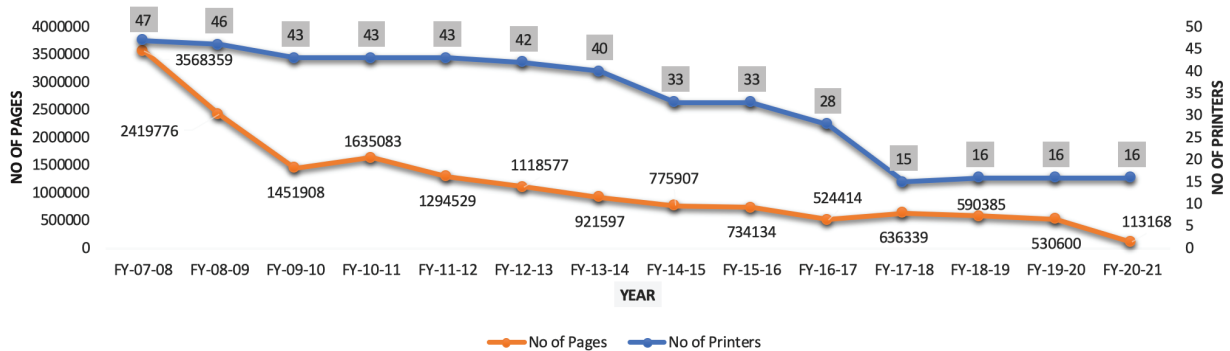

**Printer and Paper reduction efforts over the years**



## Various Educative Series Conducted in Sasken through out the year to Conserve Natural Resources

At Sasken we carry out various initiatives through out the year to ensure that we as an organization practice what we preach. Below is the list of educative series, calendarized and conducted every year.

- E-waste collection and safe disposal drives (within Sasken and in the neighbourhood)
- No paper/tissue drive every month to reduce usage of Paper
- Neighbourhood cleaning drive
- Echo and Safe Ganesha Making drive before the start of the festivals
- Educative Series from the experts in the environment field



E-waste drive and community Cleanliness drive

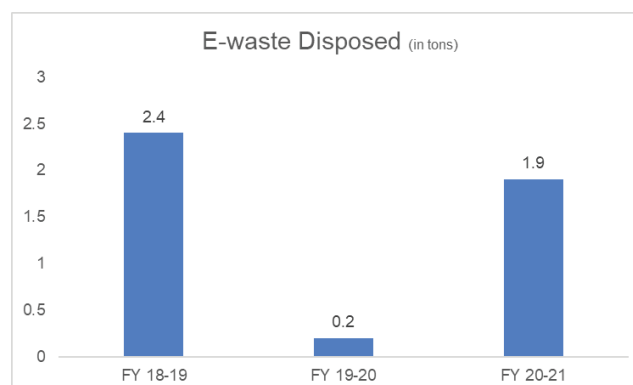



## World Nature Conservation Day

28 July 2019

World Nature Conservation Day serves as a reminder that a healthy environment is the true cornerstone of a stable and productive society. We depend on various natural resources for a safe and healthy existence. Protecting, conserving and sustainably managing them go a long way towards protecting present and future generations.

Let's make a conscious effort to protect the environment and every living organism, by adopting various lifestyle choices from today.

It's not too late to make a change!

You can adopt the following practices to make a change from today:



Carry your own container/ Use reusable tableware



Bring your own bottle



Wear clothes made with natural fibres



Use Steel/ wooden cutlery



Carry cloth bags



Adopt reusable/ compostable decoration



Use reusable hygiene products



Dear all,

To celebrate Ganesh Chaturthi coming up this weekend, our very own Shailendrasing Patil will be hosting a workshop for biodegradable Ganesha idols. Sasians interested in taking part must fill the survey provided.

Participants must also keep the following items ready for the workshop :

- Wheat flour or Maida- 1 Bowl
- Turmeric powder - 1 bowl
- Salt - 1 Tablespoon
- Water for mixing and a paint brush
- Small Qty - Kumkum, Rice, Cloves or Black pepper or Black bean, Sago/Sabudana
- Toothpick or a match stick
- Newspapers and waste cloth

Venue: MS Teams

Date: 21 August 2020

Time: 4 PM

Register here



Dear Sasians,

Plastic waste is causing considerable damage to the environment and the ecosystem. Saskaen has always been on the forefront to bring down plastic consumption in our facilities.

To minimise our plastic usage, we have procured steel water bottles for every Sasian. We will begin distribution today at all our facilities.

Let us pledge not to use plastic and replace it with an alternative eco-friendly option.

Regards,  
Team FMS



Designed by IEDS/Prakriti



Dear Sasians,

In our endeavour to save this beautiful planet from pollution, many Green Projects have been implemented in Saskaen in the past few years.

The recent one being the "RO Water Plant" to meet the drinking water requirements at Fac-Z.

While providing us with safe and hygienic drinking water, this plant will also reduce carbon emission by 0.5 Ton per month, in comparison with the conventional bubble top water cans procured regularly.

Some unique features of this RO plant, custom designed for us, are:

- Steel Bubble top/Jars instead of Plastic ones
- Steel water dispensers instead of Plastic ones
- Hot water washer Jets for washing bubble tops
- RO water output is connected to Dishwasher in the Kitchen too
- The waste water from RO Plant is fed into the domestic water tank for use in the hand wash areas



Designed by IEDS/Prakriti

Thank you all for joining hands in our journey towards eco-sustainability!

# H<sub>2</sub>O

Before it runs out!



"In our continuous efforts to Save Water, we have introduced Mumbai's "Cutting Chai" concept in the form of "Cutting Paani (Water)" across all the facilities of Saskaen in India.

This was promoted by Radio City in Mumbai, recently.

We have started serving only half glasses of water in the meetings to avoid wastage of water, as most of the people drink only half the glass of water and the rest is wasted.

We urge all Sasians to Save Water both at office and their homes, by adopting various water saving measures.

Please find the video at below link  
<https://www.youtube.com/watch?v=Lhtf4AtzWwQ>

For more details on water saving measures, you may write to us at [prakriti@saskaen.com](mailto:prakriti@saskaen.com)"



## Compost Mela!

Free Compost from Domlur Plant!

Sasians keen on gardening are welcome to collect compost generated through our plant, from P2 Land completely free of cost!





### Meet this banker turned natural farmer

We live in an age where a vast majority pursue narrow self-centred end needs without consideration to the means. Exemplary people who chose to treat a less trodden path stand out as a beacon of hope. One such person is Mr. M.K. Kailash Murthy, of Doddinduvadi village of Kollegal taluk in Chamarajanagar district. His life seems right out of a fairy tale where the end is a very happy one and the fruits of his labour are sweet indeed!

The delicious mangoes, sapota and papaya you enjoyed were the kind courtesy of Mr. Murthy who believes in the credo "No ploughing, fertilizers or weeding needed to get a good harvest."

A banker by profession, left his job to become a farmer is of the belief that "External inputs are not necessary for getting a good yield."

Inspired by Masanobu Fukuoka, a pioneer in natural farming in Japan, Mr Murthy has been practicing Natural farming for two decades after seeing the ill effects of modern farming for 4 years previous to that.

The concept of natural farming, "revolves around the theory that 'nature knows the best' and hence it is better to leave everything in her care," he says.

Mr. Murthy has won several awards and accolades including the Biodiversity Award 2009-10, Environment Award 2011-12, Udyam Ratan Award 2011. Mr Kailash Murthy is an innovative Farmer and an extraordinary Soil Engineer. He has published many papers in collaboration with Bengaluru University on bio diversity. He believes that this method of farming can reduce global warming, increases food production and protect bio-diversity.

Very soon FMS will enable a channel for Saisans who may wish to buy Natural.

Google at leisure to know more on Mr. Kailashmurthy  
<https://www.youtube.com/watch?v=FcxxVjOT08Q>  
<https://www.youtube.com/watch?v=Uop6tpKhbPe>

Designed by EED@sasken

# Sasken Times

Are we ready to take bolder steps to protect the environment?



Comparative Paper & Power consumption data for last FY & Current FY (goal)

### HERE ARE THE STATISTICS



Quantity of paper used  
~~11,240 Kgs~~ 3670 Kgs

Wood Use  
~~46 tons~~ 13 tons

Net Energy  
~~1,17,226 kWh~~ 37220 kWh

Greenhouse Gases  
~~15,044 Kgs of CO2 equiv.~~ 10409 Kgs of CO2 equiv.

Water Consumption  
~~10,40,617 Litres~~ 311796.8 Litres

Solid Waste  
~~10,365 Kgs~~ 4029.2 Kgs

NOx  
~~59.52 Kgs NOx~~ 17.7 Kgs NOx.

Purchased Energy  
~~80,594 kWh~~ 26962.5 kWh

SO2  
~~160 Kgs of SO2~~ 50.3 Kgs SO2.

Particulates  
~~34 Kgs~~ 10.4 Kgs



Hazardous Air Pollutants (HAP)  
~~15.8 Kgs~~ 4.5 Kgs

Volatile Organic Compounds (VOCs) - ~~16.7 Kgs~~ 4.9 Kgs

Total Reduced Sulfur (TRS) - ~~2.7 Kgs~~ 0.9 Kgs

Total Suspended Solids (TSS) - ~~97.62 Kgs~~ 28.1 Kgs

Chemical Oxygen Demand (COD) - ~~111.5 Kgs~~ 30.8 Kgs

Biochemical Oxygen Demand (BOD) - ~~56.7 Kgs~~ 15.4 Kgs

	In kWh/month	In kWh/year	Total Annual Carbon dioxide emissions in tons	No. of trees to offset / year
Printers Power consumption based on our usage in FY 15-16	689.66	8275.96	6.21	31.03
Printers Power consumption with reduced printing & new energy efficient printers (FY 16-17)	247.60	2971.16	2.23	11.14

For further details, please [CLICK HERE!](#)

[Read on](#)

Designed by EED@sasken



## FILMSHOW @Sasken

On the occasion of World Nature Day, Team Prakriti, in association with Vanodaya, an NGO, presents to you a film on **Tiger Conservation: The Truth about Tigers.**

5th October

4.30 pm to 5.30 pm  
Fac-Z Audi

We invite all Saisians to attend.



Education to Pourakarmikas on waste segregation



# Awards and Recognition

## Smart Engineering award By Economic Times

Economic Times Conducts an annual awards event on all India basis to recognize the leaders in the industry (corporate), who have implemented path breaking technology helping “Eco-sustainability”. Sasken was the winner for implementing Solar DC technology (2015) for the first time in Karnataka state, eventually leading to Sasken Lighting up the entire Belgavadi village in Karnataka with DC solar lighting systems for 250 houses.



## iNFHRA Award for Eco-Sustainability 2016

iNFHRA is India's premier industry body for the Workplace fraternity. It epitomises the interests of industry and trade, interfaces with Government on policy issues and interacts with international partners to promote bilateral issues. iNFHRA aims at representing on all national and local bodies to be able to convey industry viewpoints, as also communicate and debate issues relating to public-private partnerships for economic development.

Sasken was considered as the number two company among the 60 participants, for its initiatives in the Ecological sustainability.

## iNFHRA Award for Eco-Sustainability 2017

Sasken was considered as the winner for its excellent initiatives in Ecological Sustainability. A winner among more than 80 companies which participated and showcased their initiatives.



## Golden Peacock Award 2019

Golden Peacock Awards, instituted by the Institute of Directors (IOD), India in 1991, are now regarded as a benchmark of Corporate Excellence worldwide. No other Business Award today receives the kind of recognition and adulation among peers as that of Golden Peacock. Saskaen was awarded with Golden Peacock Award for its CSR projects which is largely community oriented and towards environmental sustainability.



## INFHRA Award for Eco-Sustainability 2020

Saskaen was selected as the winner for its excellent initiatives in Ecological Sustainability. A winner among more than 70 companies which participated and showcased their initiatives, despite of the pandemic year.

## ISO Certification

Saskaen has started ISO 14001 certification journey 15 Years ago, in year 2006 and since then we undergo external audits conducted by renowned auditing agency like Bureau Veritas (BV) British Standards Institution (BSI). Our Environment management system is compiled to ISO 14001:2015 standard in each audit assessment, recently audit was conducted on 13 July 2021.



# Message from the CEO & MD to the Employees

*We need to take a long-term view when it comes to using fragile natural and environmental resources. We must pass on a world that is economically, socially, and environmentally better than what we inherited to the generations to come. Our values and beliefs enshrine our commitment to adhere to pro-environmental principles. From our inception, we have pioneered, or readily adopted and promoted 'sustainable' practices.*

*We have a core group called 'Prakriti' who have made it a point to instill the ideology of embracing eco-friendly practices by all Sasians. I take this opportunity to promise that I will wholeheartedly support our sustainability initiatives. I invite all fellow Sasians to renew their pledge to embrace a culture that is committed to helping our natural environment flourish.*

**Warm regards,  
Rajiv C Mody**

Chairman, Managing Director & CEO  
Sasken Technologies Limited





SASKEN



## Sasken Technologies Ltd.

No 139/25, Domlur Inner Ring Road, Amar Jyothi Layout, Bangalore 560071.  
CIN# L72100KA1989PLC014226

### Report by:

Contact Details: +919886002009 | [prakriti@sasken.com](mailto:prakriti@sasken.com)

This document is printed on Paper with 100% Recycled Fibre